

**INTERNATIONAL  
PRACTICAL SHOOTING  
CONFEDERATION**

**HANDGUN TARGET ARRAY BOOK**

**SEPTEMBER, 2023 EDITION**

International Range Officer Association (IROA)  
64 Nicholson Crescent, Minesing Ontario  
Canada L9X 0G9

Tel: +1 705 733 6989 WhatsApp +1 705 7336989

Email: [iroa@ipsc.org](mailto:iroa@ipsc.org) Web: [www.ipsc.org/iroa](http://www.ipsc.org/iroa)

Copyright © 2023 International Range Officer Association (IROA)

## SECTION 1: Individual IPSC Targets

- 1.1 When **cuttingscoring** IPSC targets or IPSCno-shoots, only the lower portion, or a diagonal portion, or one of the sides can be cut, and a replacement non-scoring border must be fitted (see Rule 4.2.3.2):

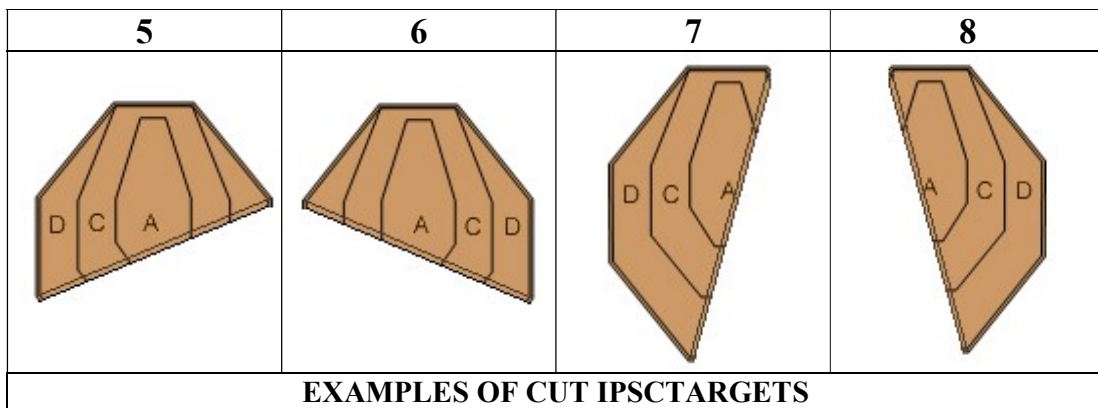
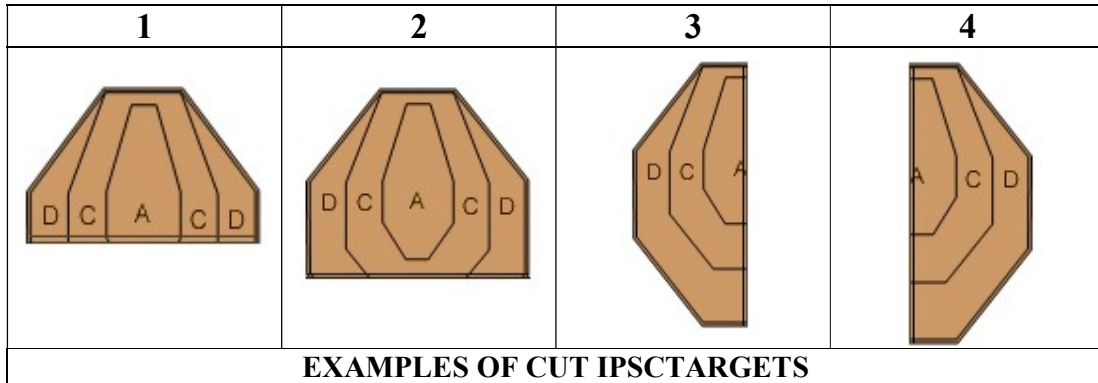

- 1.2 When **painting** scoring IPSC targets or IPSCno-shoots, only the lower portion, or a diagonal portion, or the sides can be painted. A replacement non-scoring border is not necessary, but the use of tape to create a sharply defined boundary of the Hard Cover is recommended (see Rule 4.2.3.3):

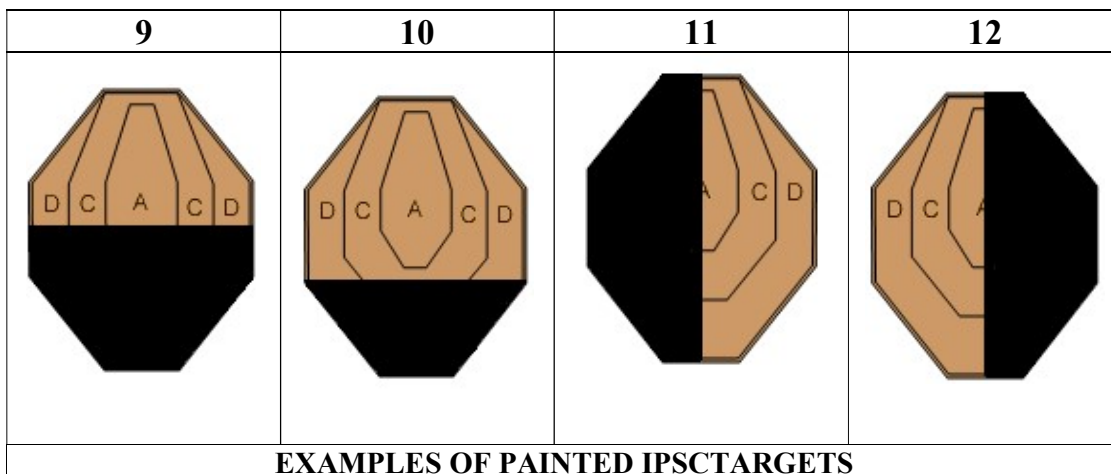

13	14	15	16
<b>EXAMPLES OF PAINTED IPSC TARGETS</b>			

17	18	19	20
	Intentionally Left Blank	Intentionally Left Blank	Intentionally Left Blank

**1.3** If a single IPSC target is cut vertically to represent two IPSC targets, the two pieces must be placed at least 1m apart. However, a scoring IPSC target may be painted with a vertical strip of Hard Cover, provided it is not treated as more than a single IPSC target (see Rule 4.1.5):

21	22	23
<b>ACCEPTABLE</b>	<b>ACCEPTABLE</b>	<b>NOT ACCEPTABLE</b>

- 1.4 A portion of one scoring IPSCtarget or IPSCno-shoot must not be placed within the boundaries of another scoring IPSCtarget or IPSCno-shoot, and a scoring IPSCtarget or IPSCno-shoot must not be hollowed:

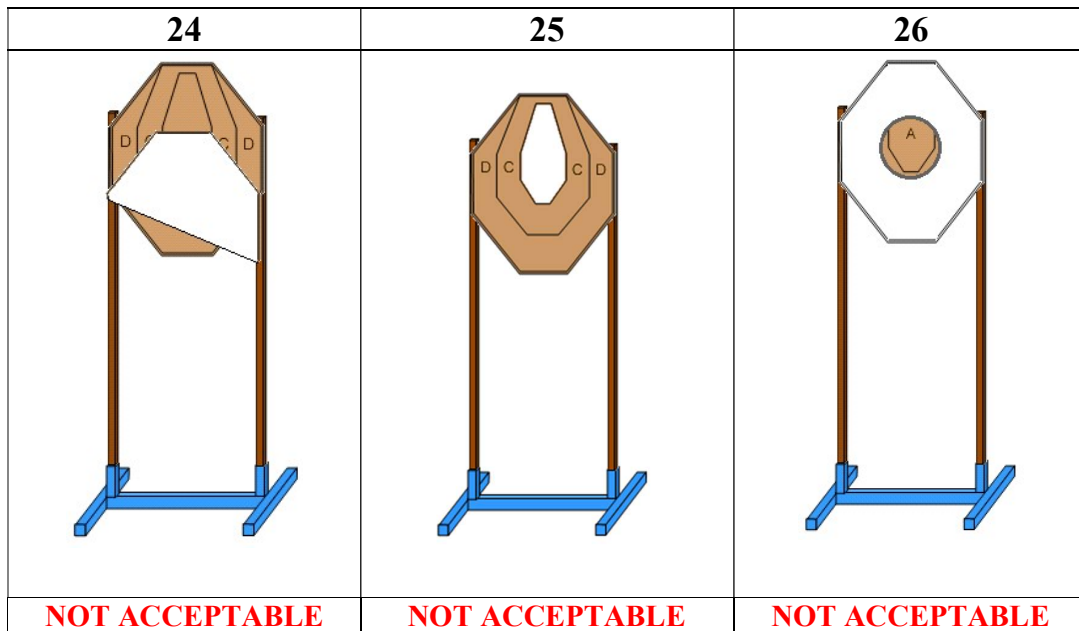

- 1.5 The top of the IPSC Target or IPSCNo-shoot must never exceed 1.8m in height and IPSC Mini Target or IPSC Mini No-shoots must never exceed 1.6m in height.

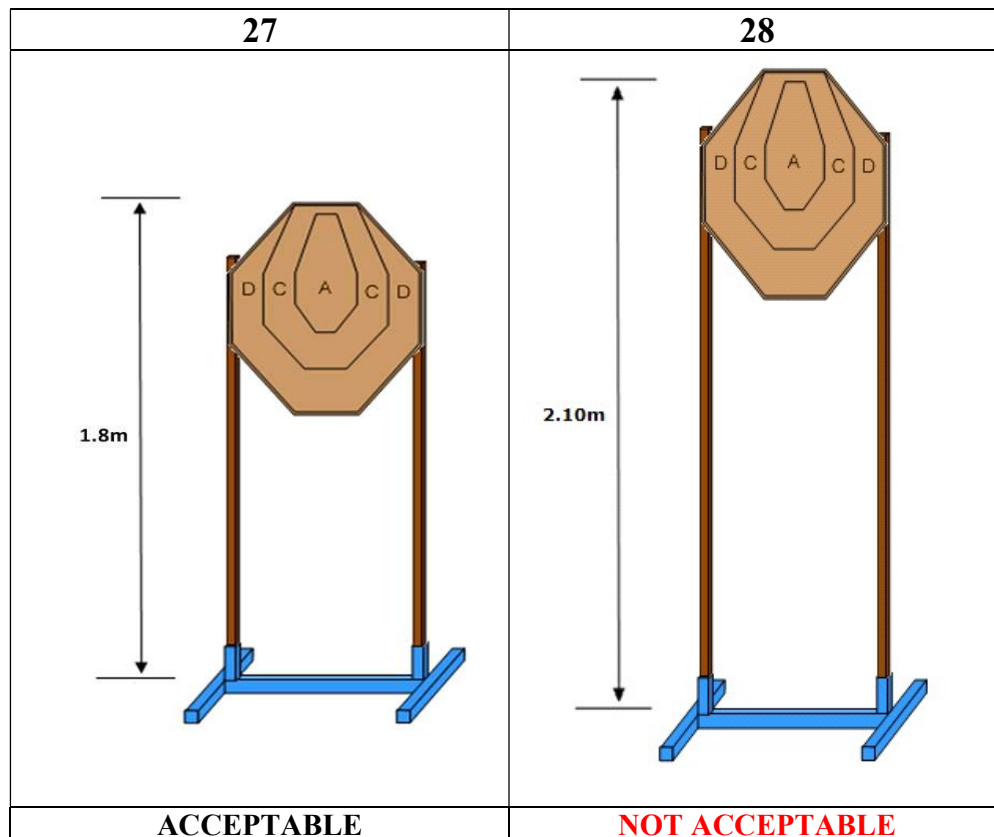

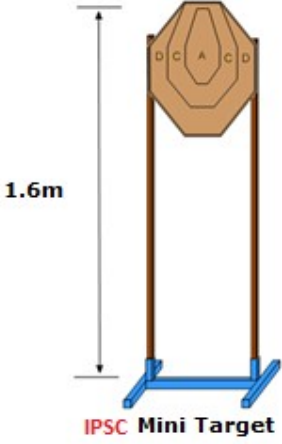
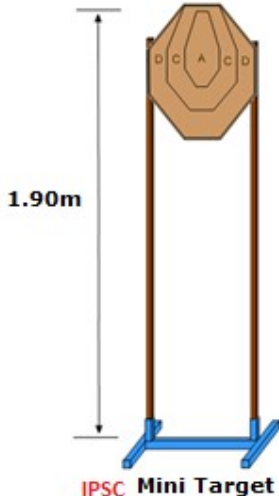
29	30
 <p data-bbox="402 457 467 483">1.6m</p> <p data-bbox="483 693 673 718">IPSC Mini Target</p>	 <p data-bbox="893 415 974 441">1.90m</p> <p data-bbox="971 693 1161 718">IPSC Mini Target</p>
<b>ACCEPTABLE</b>	<b>NOT ACCEPTABLE</b>

1.6 When a lack of contrast with the surrounding area or background necessitates that a different color of IPSC Target be used. (Rule 4.1.2.1). Most applicable at long distances used at mini rifle and rifle matches.

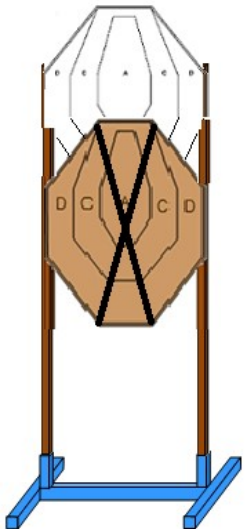
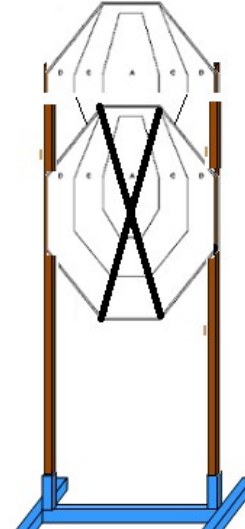
<b>EXAMPLES OF IPSC TARGETS</b>	
31	32
	
<b>ACCEPTABLE</b>	<b>NOT ACCEPTABLE</b>

## SECTION 2: Multiple IPSC Targets

2.1 The upper portion of scoring IPSC targets or IPSC no-shoots must never be removed or concealed:

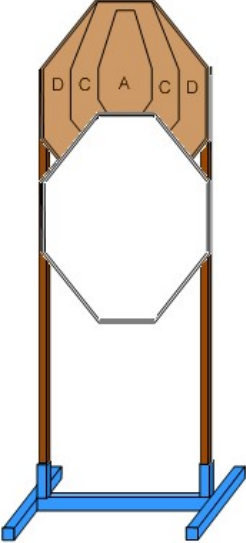
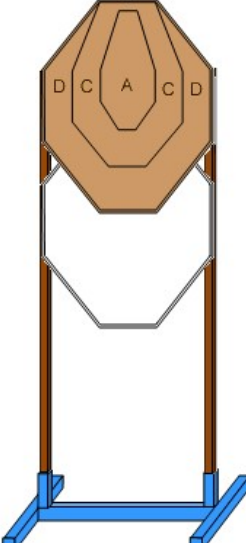
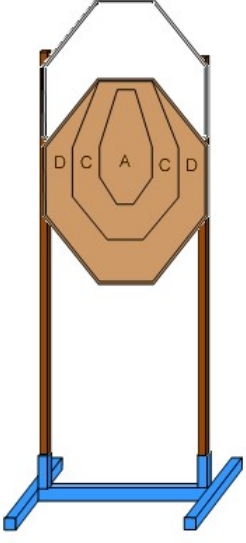
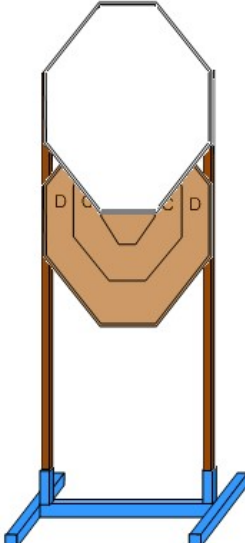
33	34	35	36
			
<b>ACCEPTABLE</b>	<b>NOT ACCEPTABLE</b>	<b>NOT ACCEPTABLE</b>	<b>NOT ACCEPTABLE</b>

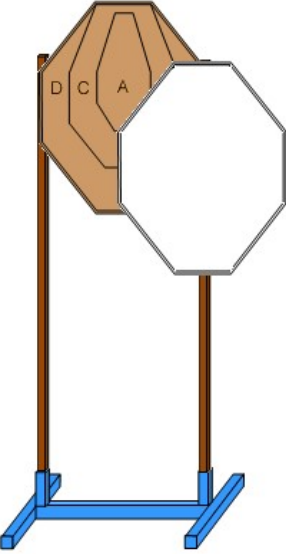
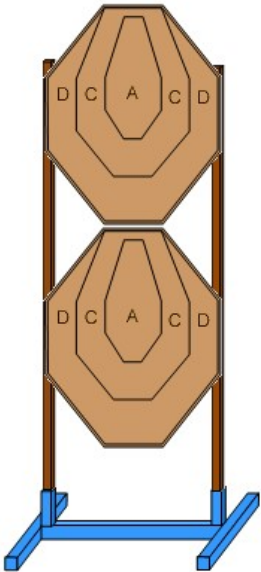
37	38	39
		<p>Intentionally Left Blank</p>
<b>ACCEPTABLE</b>	<b>ACCEPTABLE</b>	

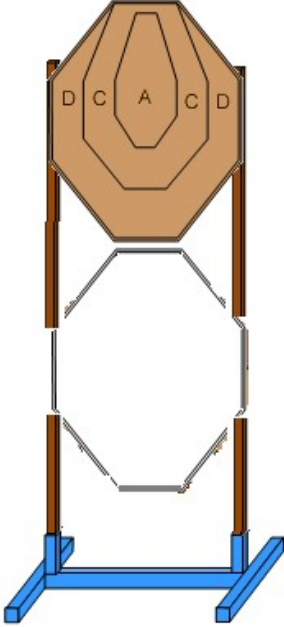
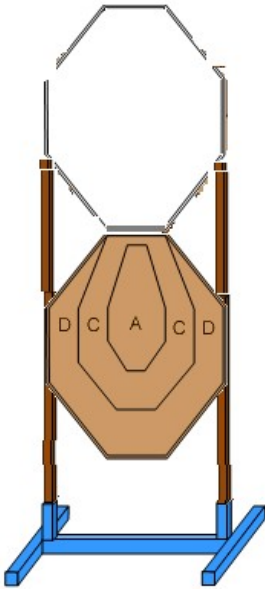
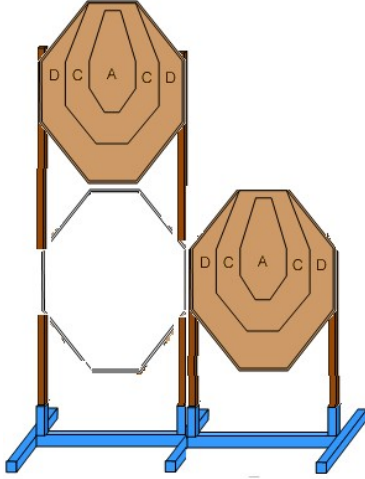
40	41	42
		
<b>NOT ACCEPTABLE</b>	<b>NOT ACCEPTABLE</b>	<b>NOT ACCEPTABLE</b>

2.2 Whole IPSC targets must not be used as Hard Cover (see Rule 4.1.4.1). To segregate two adjacent scoring IPSC targets, use a IPSC no-shoot:

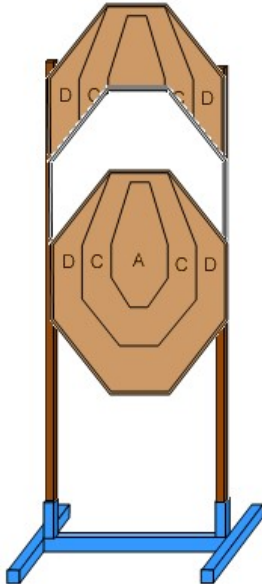
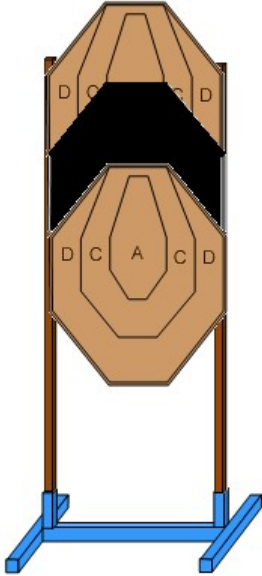
43	44
	
<b>ACCEPTABLE</b>	<b>NOT ACCEPTABLE</b>

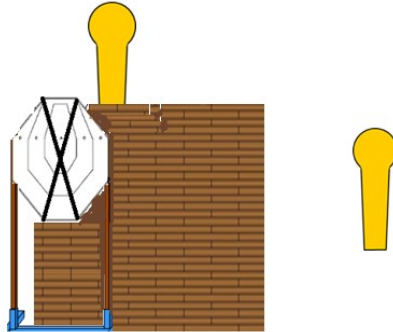
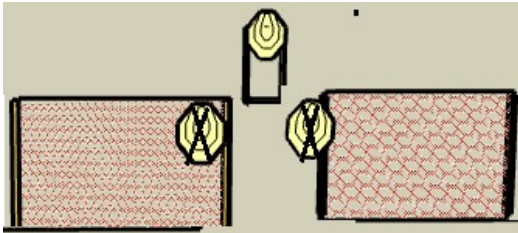
45	46
	
<b>NOT ACCEPTABLE</b>	<b>NOT ACCEPTABLE</b>

2.3 A IPSCno-shoot may be placed to the forward or to the rear of two adjoining IPSC targets:

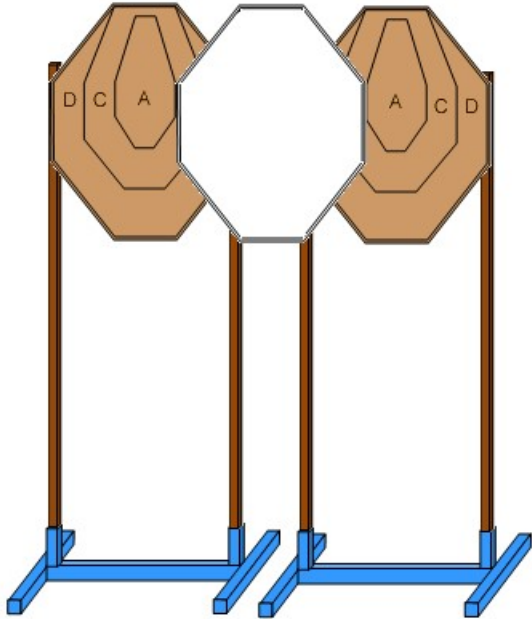
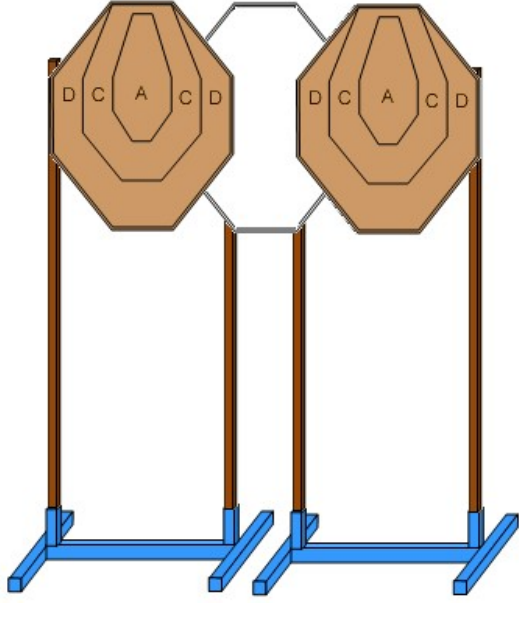
47	48
	
<b>ACCEPTABLE</b>	<b>NOT ACCEPTABLE</b>



2.4 Overlapping IPSC targets can be comprised of just two scoring IPSC targets, or two scoring IPSC targets with a IPSCno-shoot separating them:

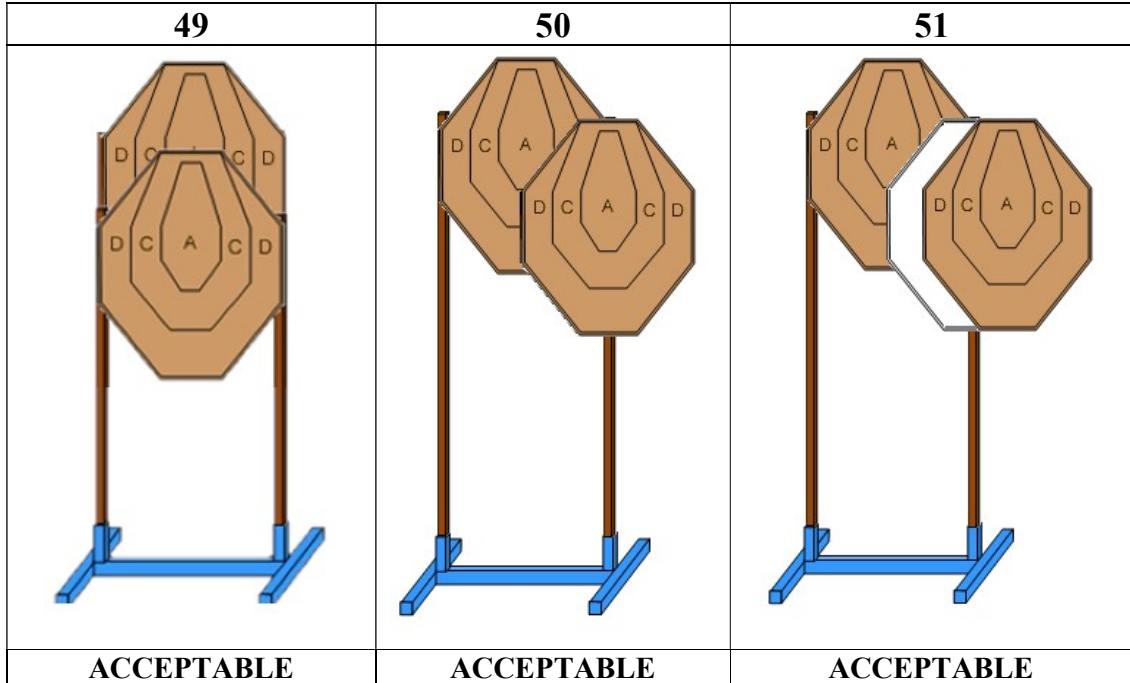

2.5 IPSC Target arrays which are illogical or impractical, or which are overly complicated, thereby making them difficult to replace consistently for the duration of a match, will not be ACCEPTABLE:

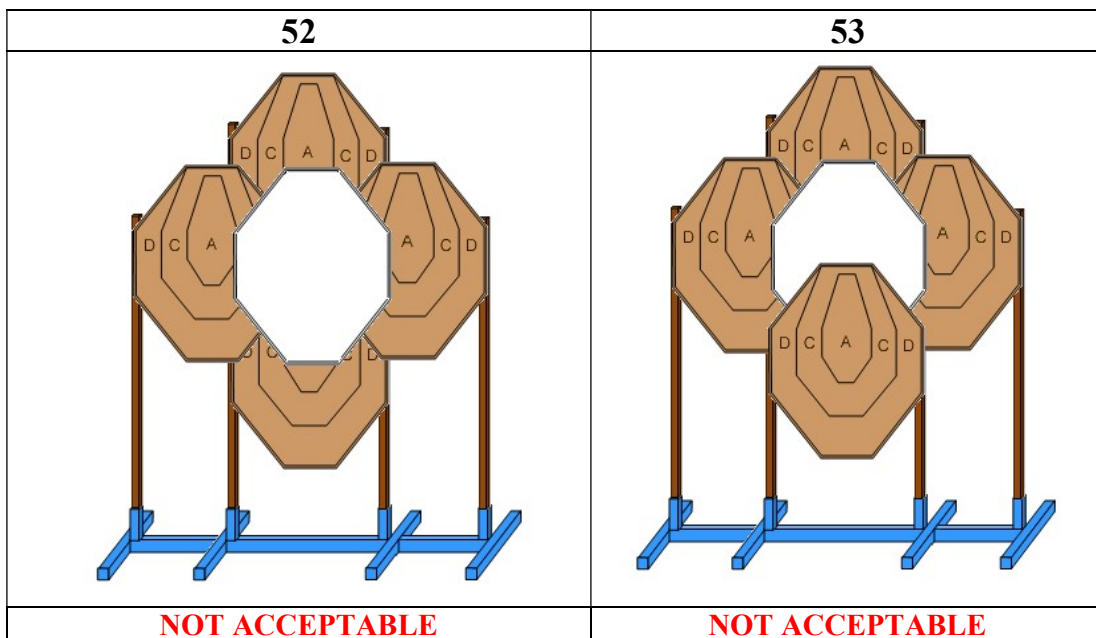

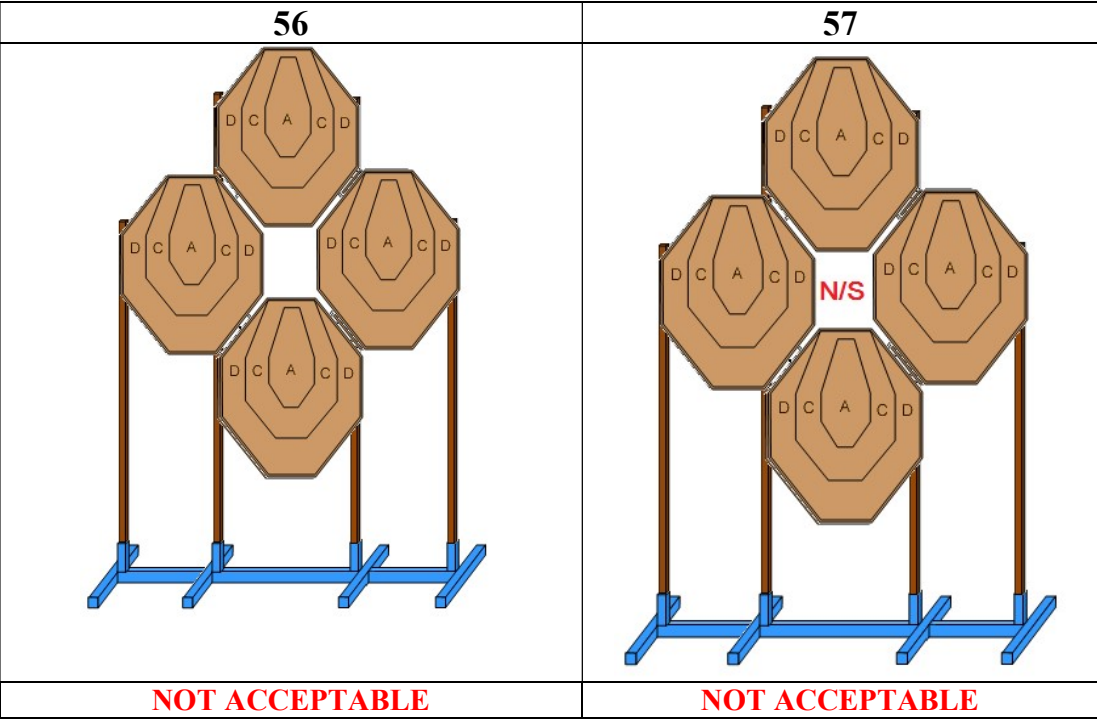
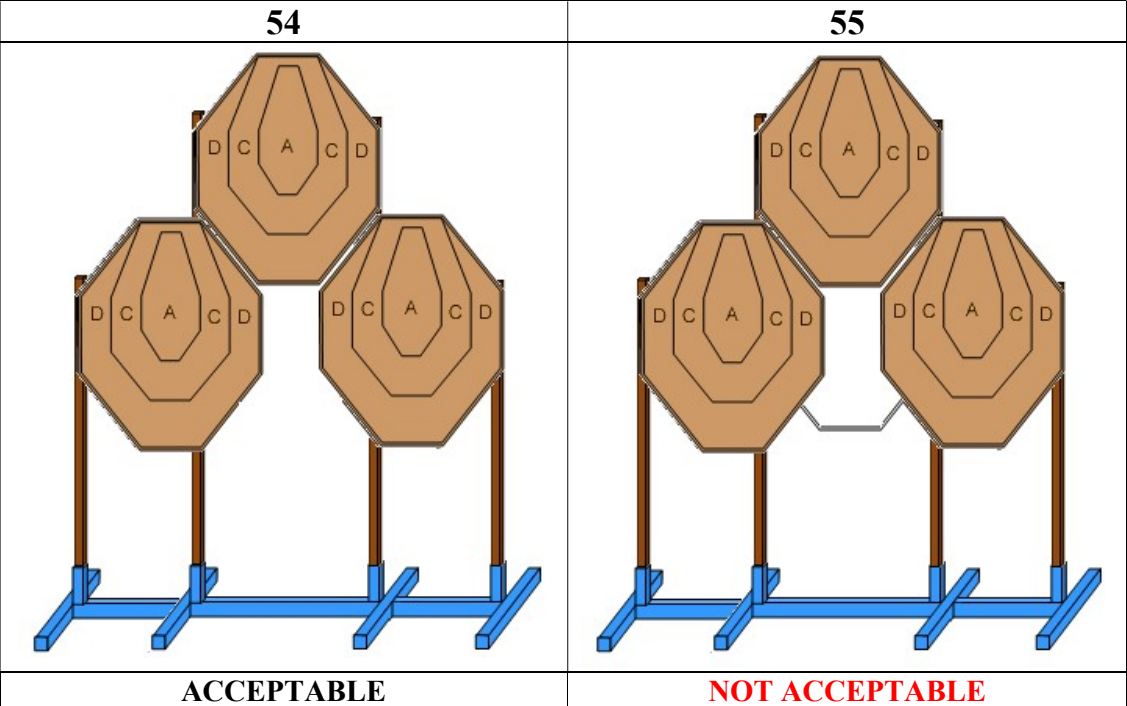

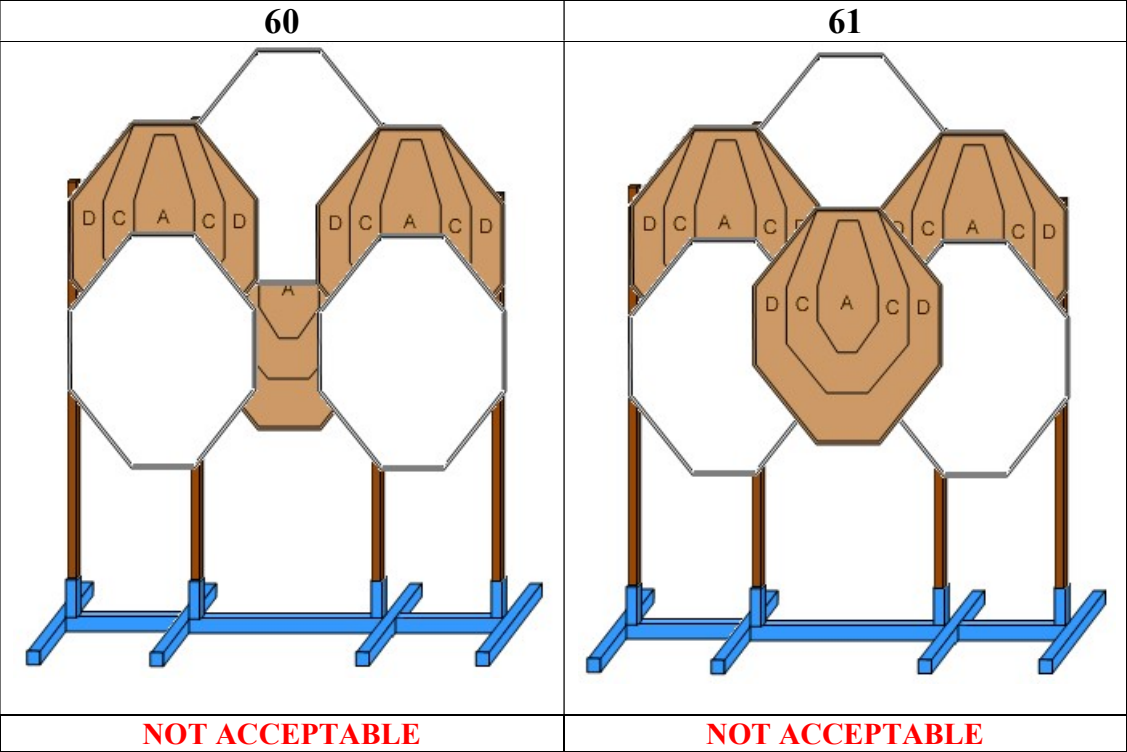
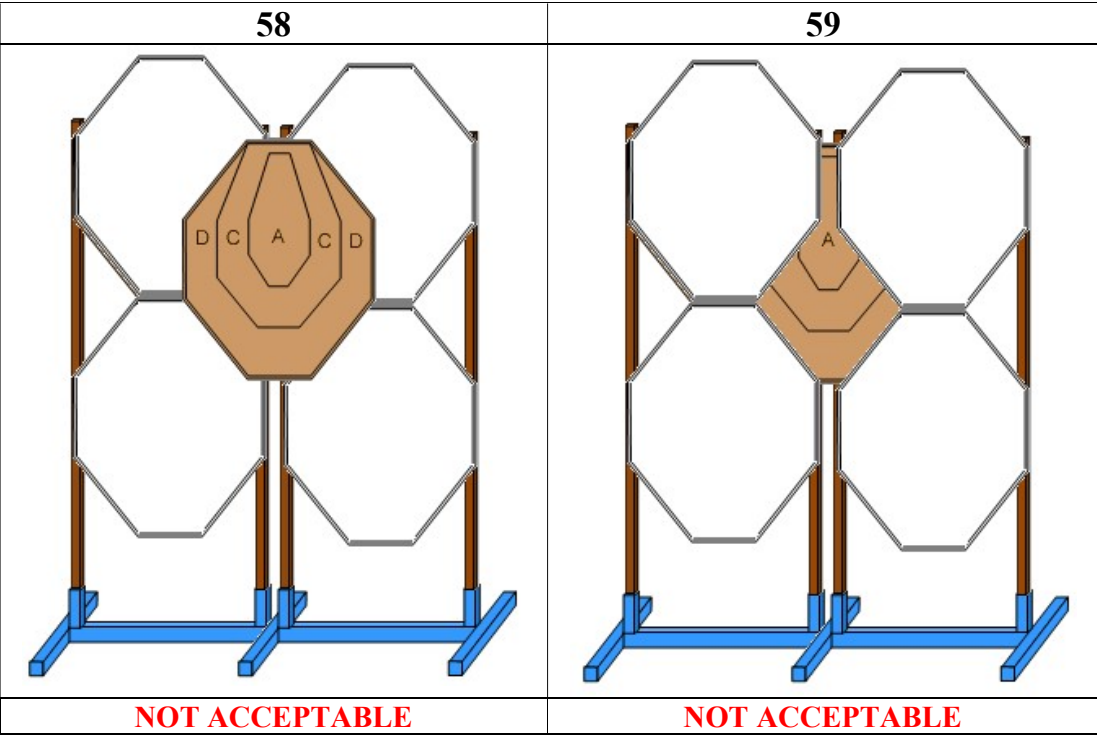

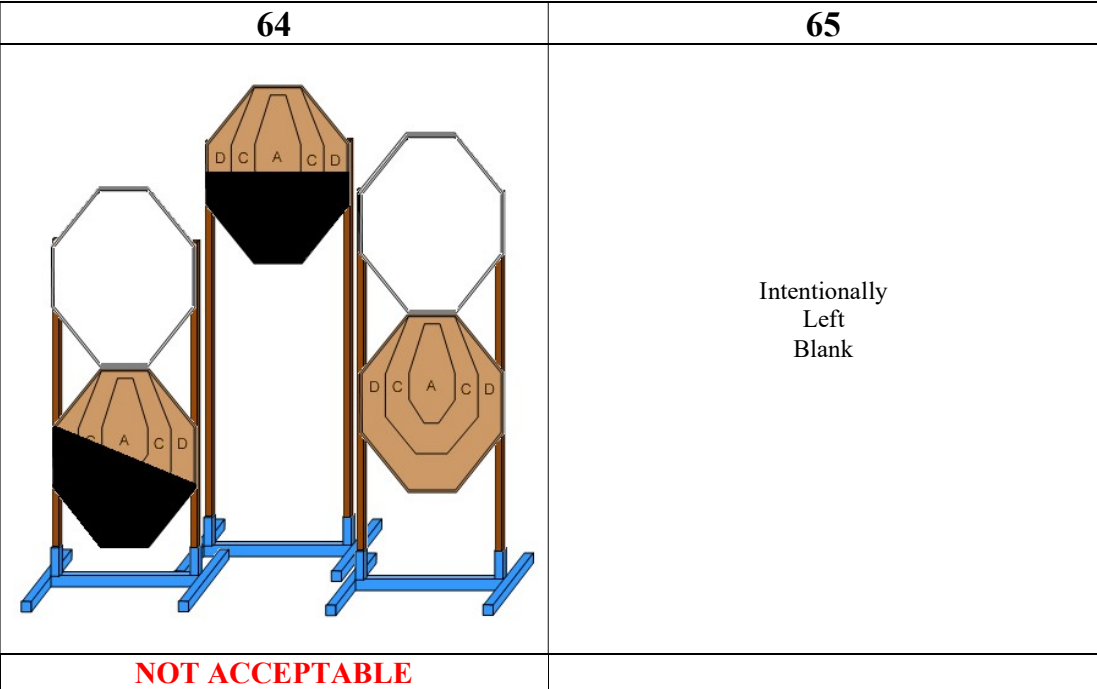
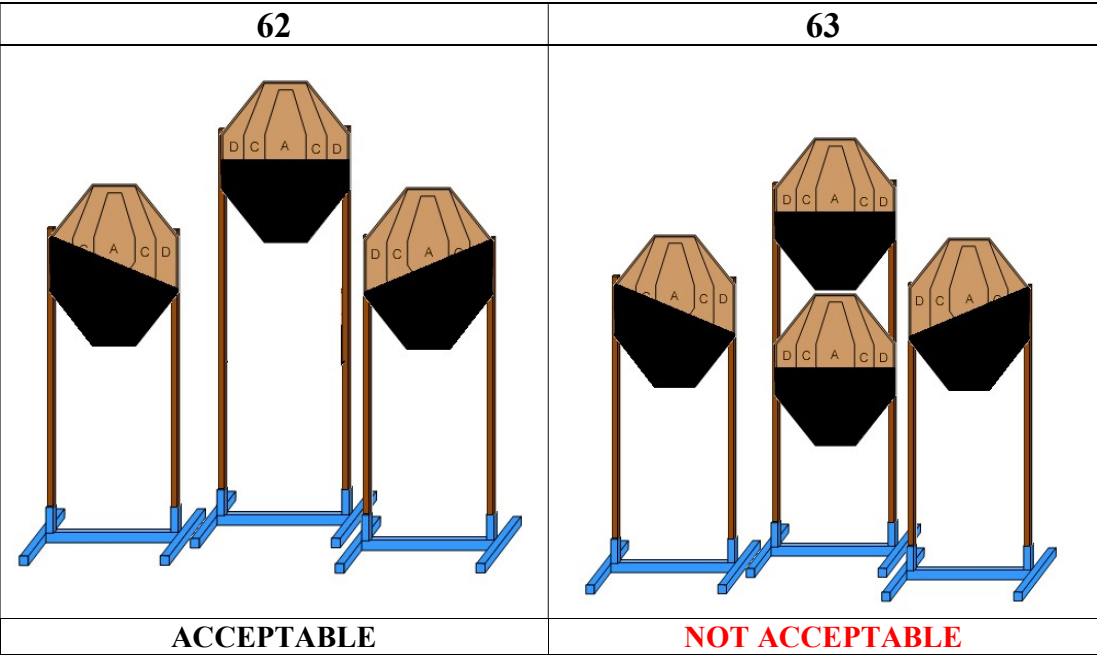

## SECTION 3: Mixing IPSC Targets & IPSC Metal Targets

3.1 When mixed together, IPSC Targets and IPSC Metal Targets must offer a practical presentation:

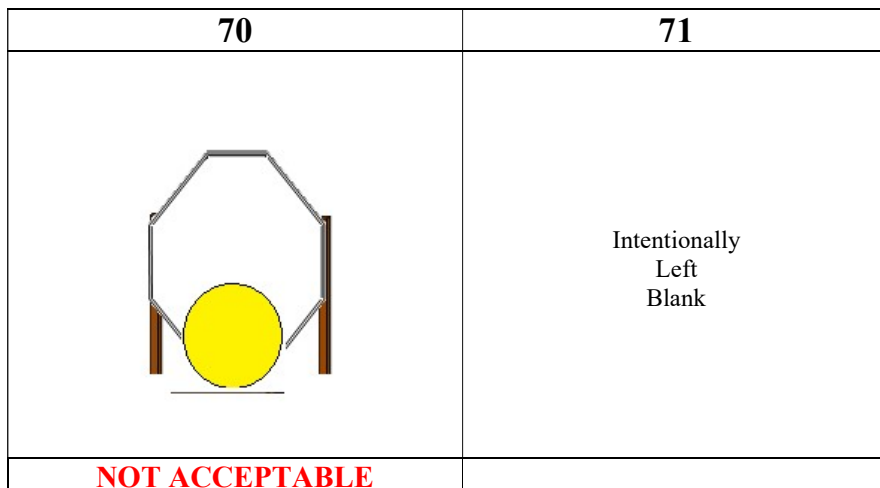
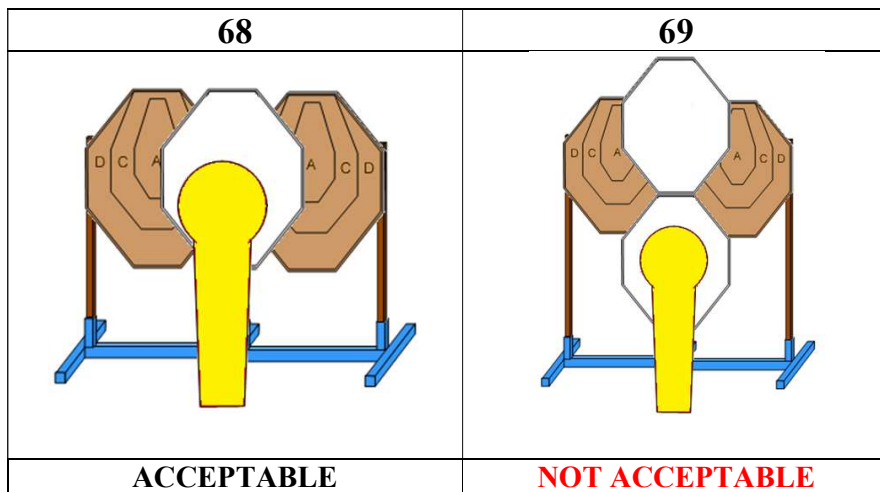
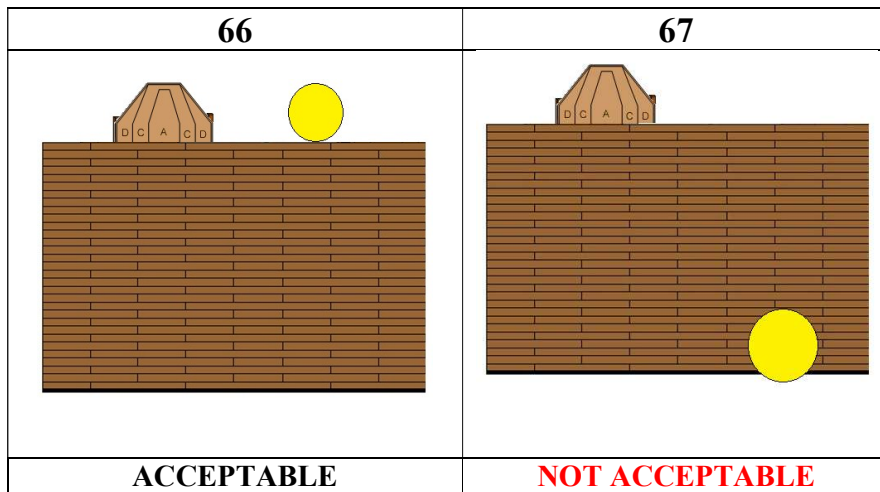

## SECTION 4: Carnival Target Arrays

- 4.1 Target arrays such as "stars", "plate racks", "trees", and similar devices are NOT ACCEPTABLE. However, up to 2 authorized IPSC Metalplates, presented above a sturdy common base, may be ACCEPTABLE.

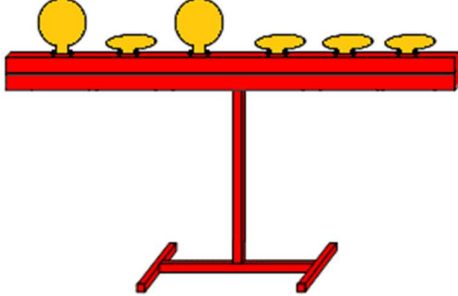
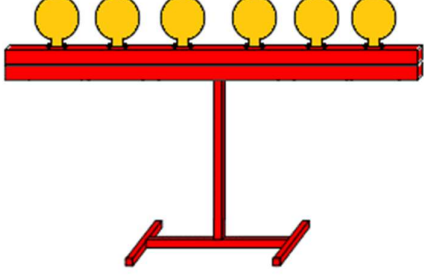
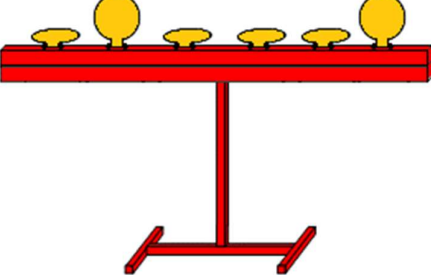
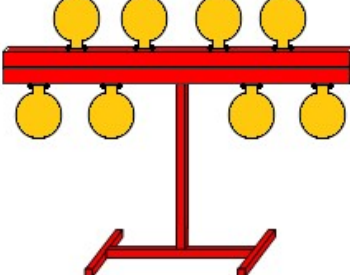
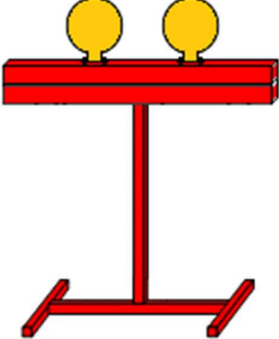
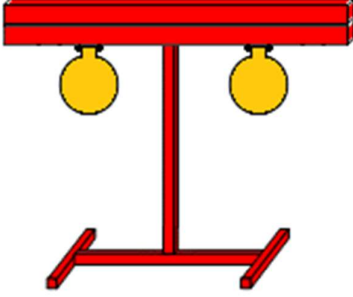
<p><b>72</b></p>  <p style="text-align: center;"><b>ACCEPTABLE (any combination of 2)</b></p>	<p><b>73</b></p>  <p style="text-align: center;"><b>NOT ACCEPTABLE</b></p>
<p><b>74</b></p>  <p style="text-align: center;"><b>ACCEPTABLE (any combination of 2)</b></p>	<p><b>75</b></p>  <p style="text-align: center;"><b>NOT ACCEPTABLE</b></p>
<p><b>76</b></p>  <p style="text-align: center;"><b>ACCEPTABLE</b></p>	<p><b>77</b></p>  <p style="text-align: center;"><b>NOT ACCEPTABLE</b></p>

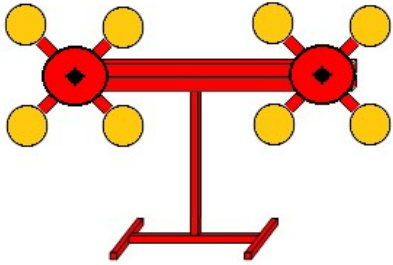
78	79
	<p data-bbox="1052 310 1182 401">Intentionally Left Blank</p>
<p data-bbox="435 594 716 623"><b>NOT ACCEPTABLE</b></p>	

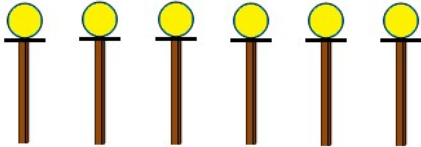
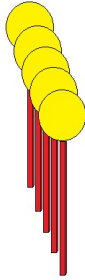

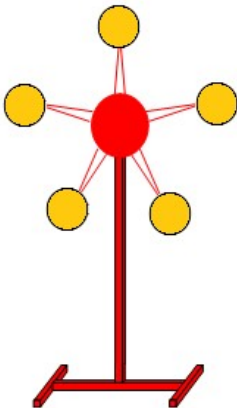
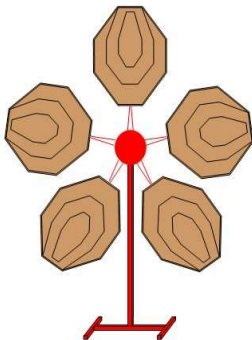
80	81
	
<p data-bbox="467 1134 672 1163"><b>ACCEPTABLE</b></p>	<p data-bbox="976 1134 1256 1163"><b>NOT ACCEPTABLE</b></p>

82	83
	
<p data-bbox="435 1749 716 1778"><b>NOT ACCEPTABLE</b></p>	<p data-bbox="976 1749 1256 1778"><b>NOT ACCEPTABLE</b></p>

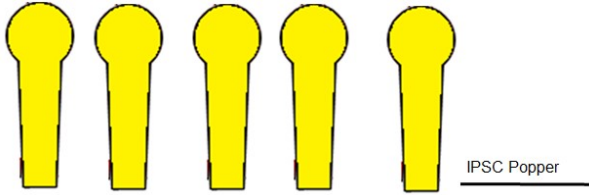
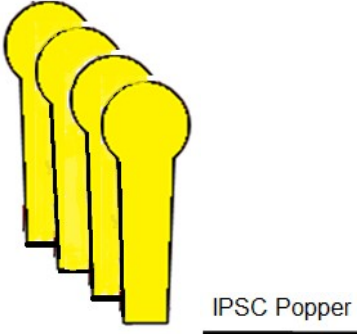

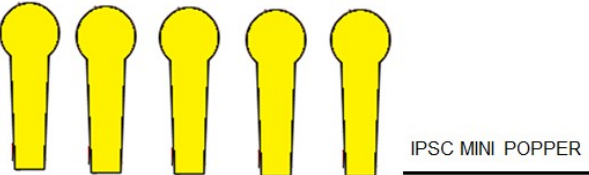
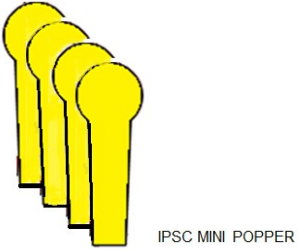
<b>84</b>	<b>85</b>
 <p>IPSC Popper</p>	 <p>IPSC Popper</p>
<b>ACCEPTABLE</b>	<b>ACCEPTABLE</b>

<b>86</b>	<b>87</b>
 <p>IPSC MINI POPPER</p>	 <p>IPSC MINI POPPER</p>
<b>ACCEPTABLE</b>	<b>ACCEPTABLE</b>

<b>88</b>	<b>89</b>
 <p>IPSC Popper</p>	 <p>IPSC MINI POPPER</p>
<b>NOT ACCEPTABLE</b>	<b>NOT ACCEPTABLE</b>



## SECTION 5: Mixed Target Types and Size Arrays

- 5.1 The following types and sizes of IPSC Targets must not be included together in the same target array: IPSC Targets and IPSC Mini Targets; or IPSC Poppers and IPSC Mini Poppers (see Rule 4.1.1.2)

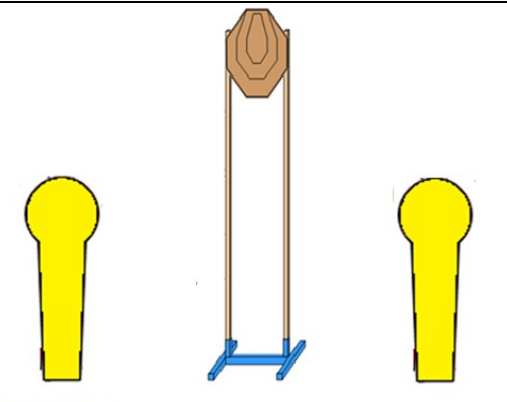
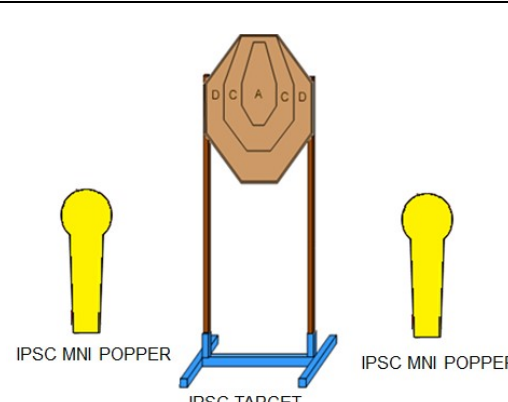
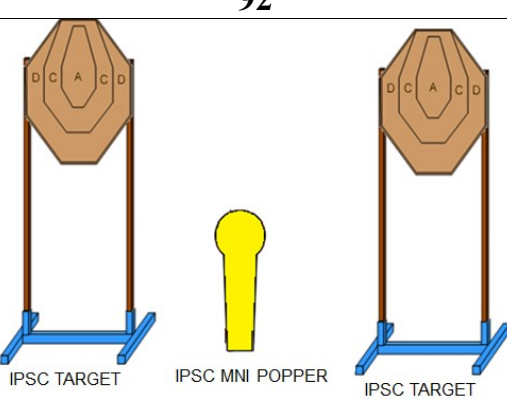
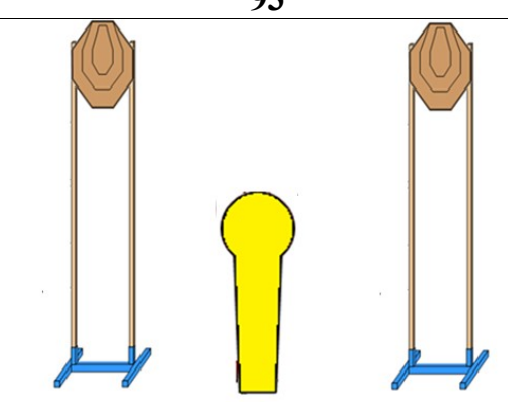
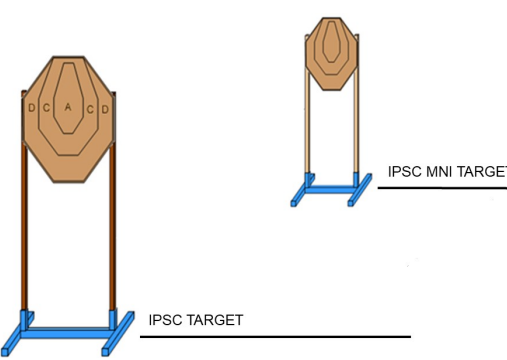
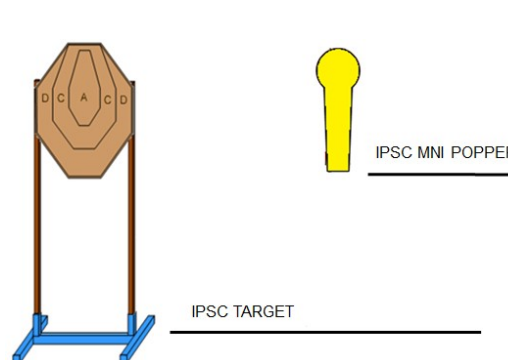
<p><b>90</b></p>  <p style="text-align: center;">IPSC POPPER      IPSC MINI TARGET      IPSC POPPER</p> <p style="text-align: center;"><b>ACCEPTABLE</b></p>	<p><b>91</b></p>  <p style="text-align: center;">IPSC MINI POPPER      IPSC TARGET      IPSC MINI POPPER</p> <p style="text-align: center;"><b>ACCEPTABLE</b></p>
<p><b>92</b></p>  <p style="text-align: center;">IPSC TARGET      IPSC MINI POPPER      IPSC TARGET</p> <p style="text-align: center;"><b>ACCEPTABLE</b></p>	<p><b>93</b></p>  <p style="text-align: center;">IPSC MINI TARGET      IPSC POPPER      IPSC MINI TARGET</p> <p style="text-align: center;"><b>ACCEPTABLE</b></p>
<p><b>94</b></p>  <p style="text-align: center;">IPSC TARGET      IPSC MINI TARGET</p> <p style="text-align: center;"><b>NOT ACCEPTABLE</b></p>	<p><b>95</b></p>  <p style="text-align: center;">IPSC TARGET      IPSC MINI POPPER</p> <p style="text-align: center;"><b>ACCEPTABLE</b></p>

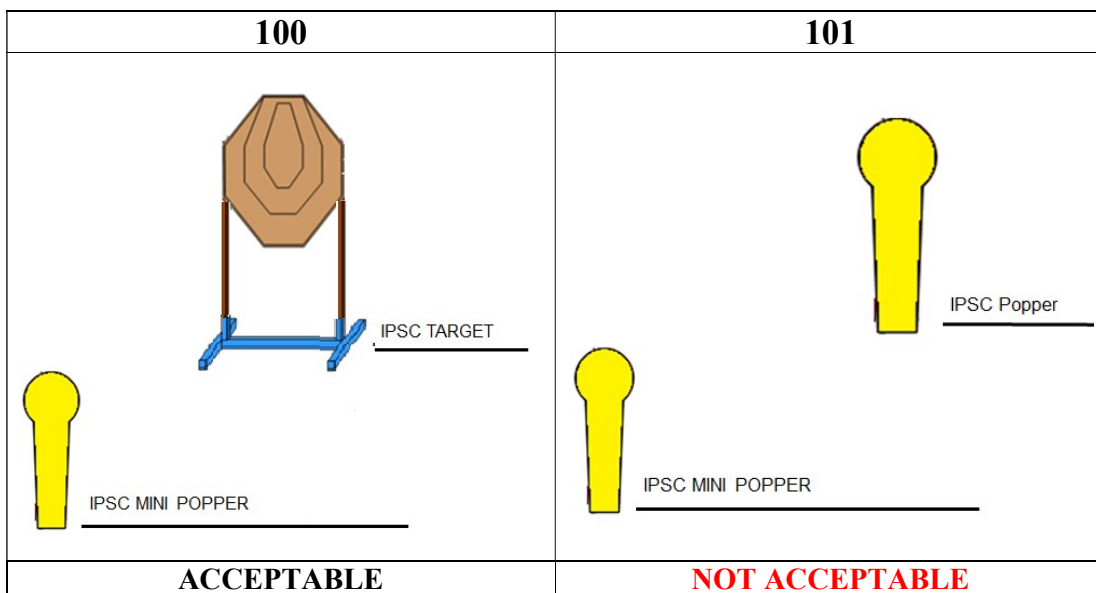
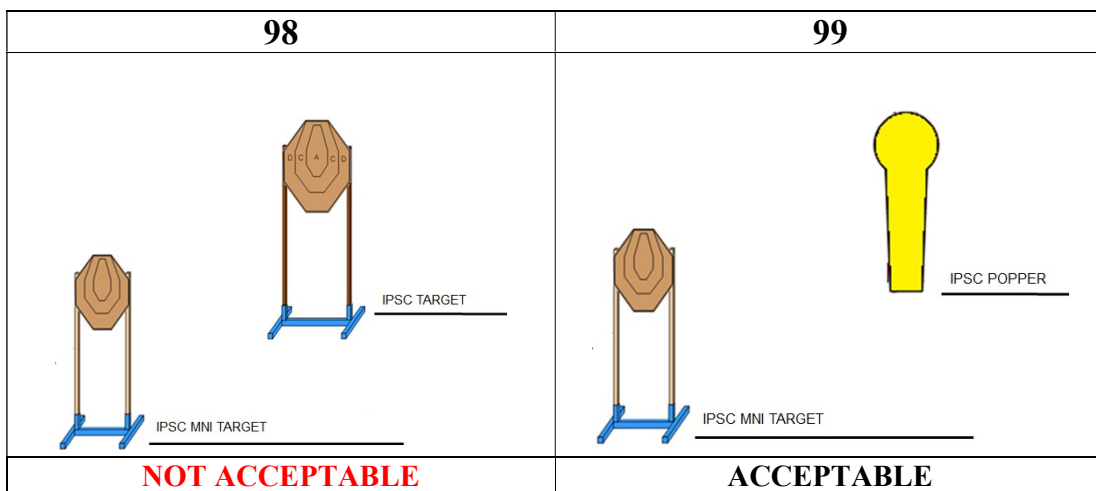
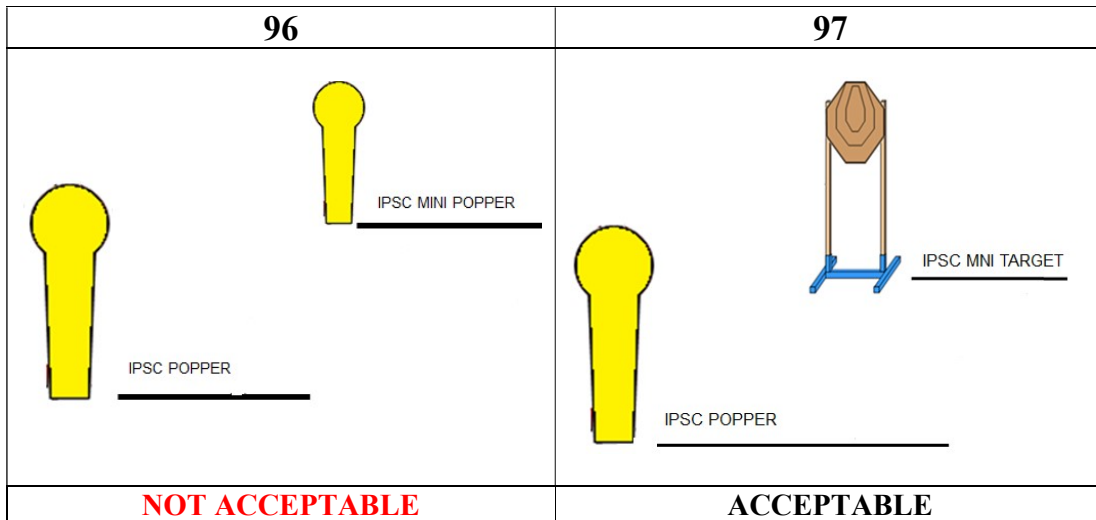

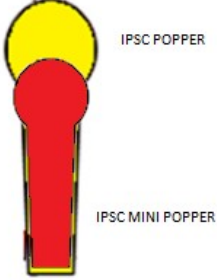
<b>102</b>	<b>103</b>
 <p>IPSC POPPER</p> <p>IPSC MINI POPPER</p>	<p>Intentionally Left Blank</p>
<b>NOT ACCEPTABLE</b>	

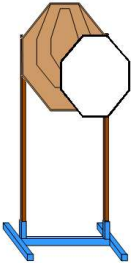
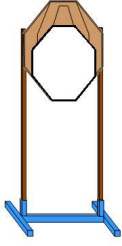
<b>104</b>	<b>105</b>
	
<b>NOT ACCEPTABLE</b>	<b>NOT ACCEPTABLE</b>

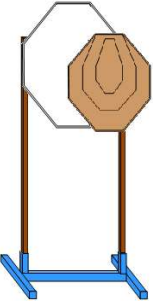
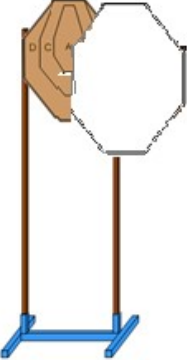
<b>106</b>	<b>107</b>
	
<b>NOT ACCEPTABLE</b>	<b>NOT ACCEPTABLE</b>

## SECTION 6: Stage Design

6.1 The following Cooper tunnel designs must be followed

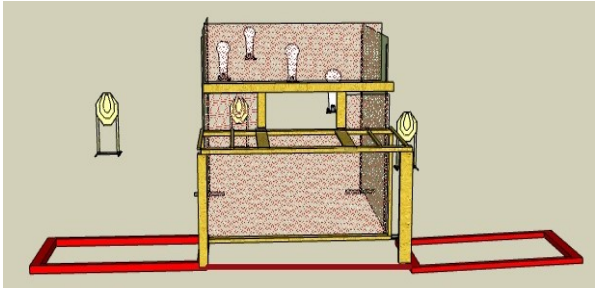
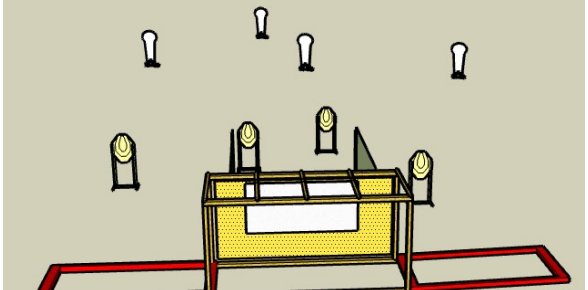
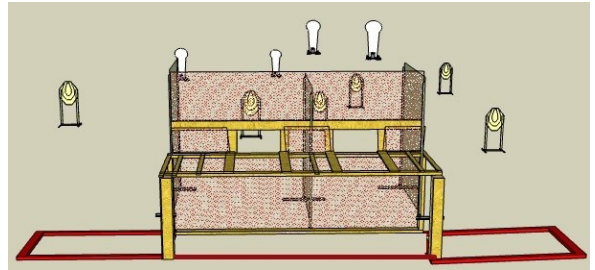
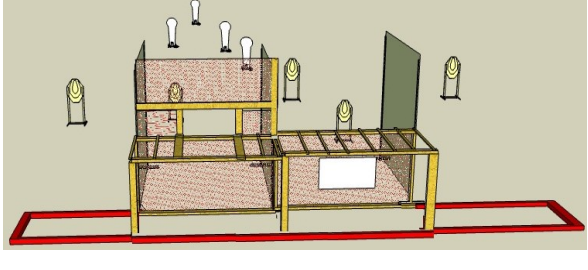
<b>EXAMPLES OF COOPER TUNNELS</b>	
<p><b>108</b></p>  <p style="text-align: center;"><b>ACCEPTABLE</b></p>	<p><b>109</b></p>  <p style="text-align: center;"><b>NOT ACCEPTABLE</b></p>
<p><b>110</b></p>  <p style="text-align: center;"><b>ACCEPTABLE</b></p>	<p><b>111</b></p>  <p style="text-align: center;"><b>NOT ACCEPTABLE</b></p>

6.2 The following tunnel designs must be followed

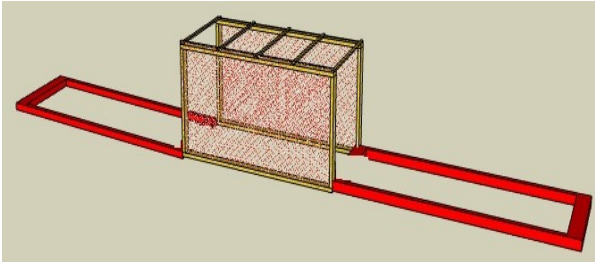
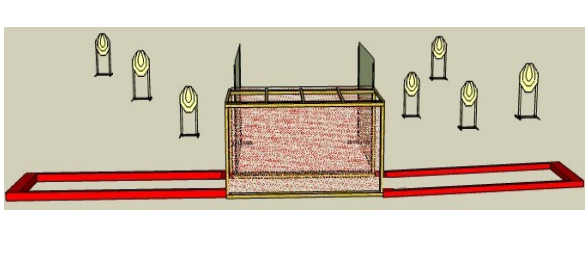
<b>EXAMPLES OF TUNNELS</b>	
<p><b>112</b></p>  <p style="text-align: center;"><b>ACCEPTABLE</b></p>	<p><b>113</b></p>  <p style="text-align: center;"><b>ACCEPTABLE</b></p>

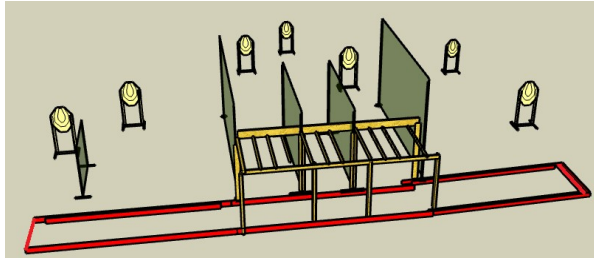
114	115
 <p data-bbox="363 485 643 520"><b>NOT ACCEPTABLE</b></p>	<p data-bbox="1049 281 1179 365">Intentionally Left Blank</p>

## SECTION 7: Swingers

- 6.3** When using Swinger IPSC Metal Plates, only two (2) IPSCMetalPlates can be used in the swinger at the same time.

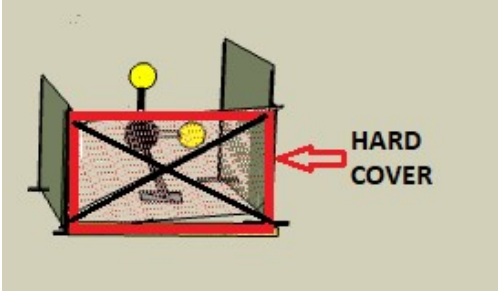
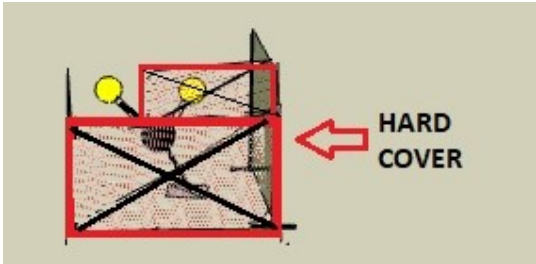
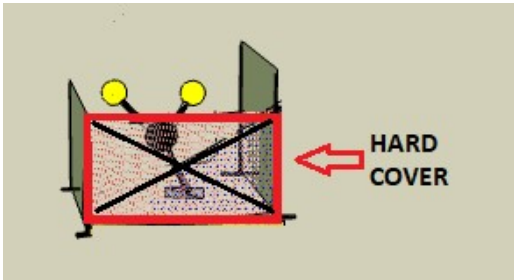
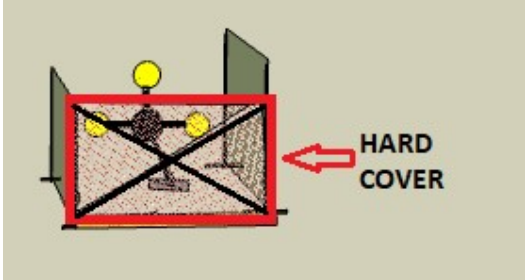
<b>EXAMPLES OF SWINGER IPSC METAL PLATES</b>	
<b>116</b>	<b>117</b>
	
<b>ACCEPTABLE (Only one IPSC Metal Plate must be visible)</b>	<b>ACCEPTABLE (Only one IPSC Metal Plate must be visible)</b>
<b>118</b>	<b>119</b>
	
<b>NOT ACCEPTABLE</b>	<b>NOT ACCEPTABLE</b>

6.4 When using Swingers, IPSC metal No shoots or IPSC paper No shoots must remain still.

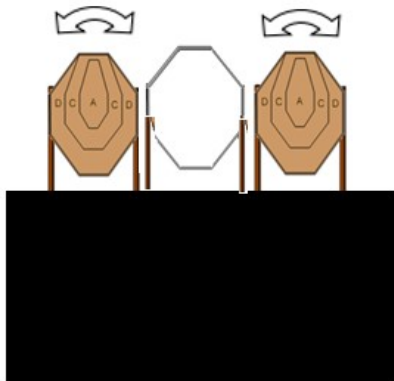
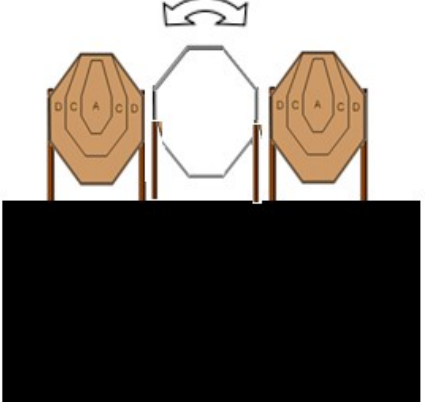
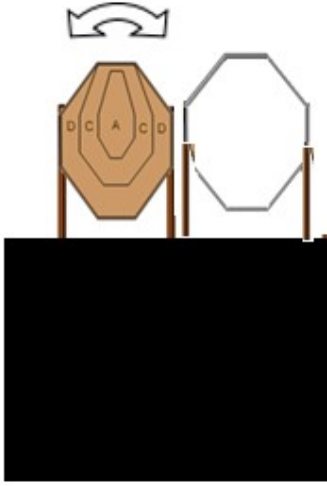
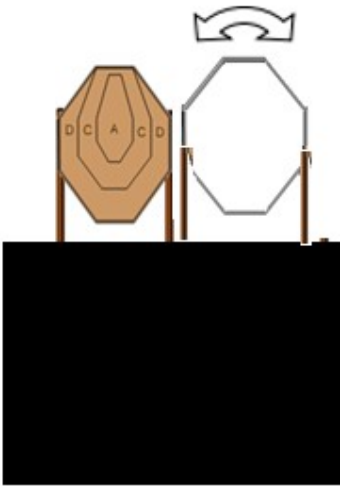
<b>EXAMPLES OF SWINGER IPSC TARGETS</b>	
<b>120</b> 	<b>121</b> 
<b>ACCEPTABLE</b>	<b>NOT ACCEPTABLE</b>
<b>122</b> 	<b>123</b> 
<b>ACCEPTABLE</b>	<b>NOT ACCEPTABLE</b>

124

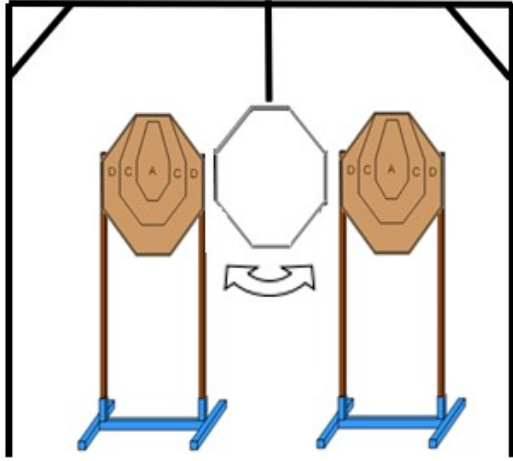

**NOT ACCEPTABLE**

125

Intentionally  
Left  
Blank



## SECTION 8: Shooting Area

6.5 When a competitor ready condition requires that the firearm or magazines, or speed loaders be placed on a table or similar, the table or similar must be inside the clearly demarcated shooting area.

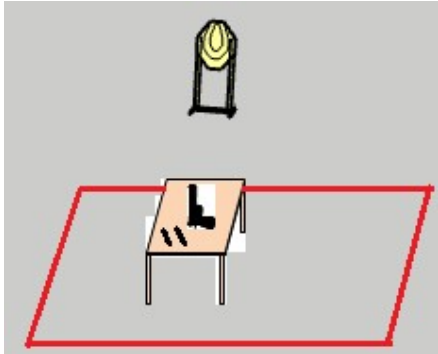
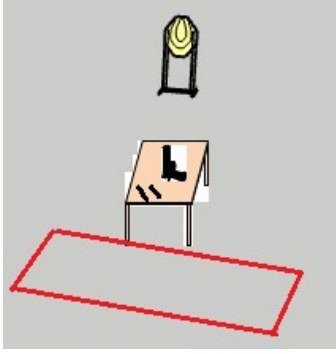
126	127
	
<b>ACCEPTABLE</b>	<b>NOT ACCEPTABLE</b>

6.6 When using a mechanical activator (e.g. a rope, a lever, pedal, flap, door, etc), the mechanical activator must be inside the clearly demarcated shooting area.

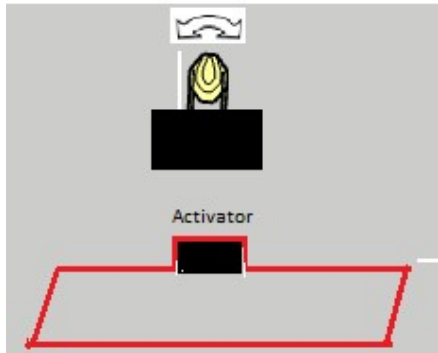
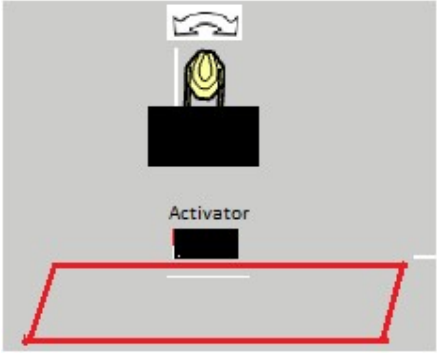
128	129
 <p>Activator</p>	 <p>Activator</p>
<b>ACCEPTABLE</b>	<b>NOT ACCEPTABLE</b>